

Ionic conductors

Lecture 7

Bartomeu Monserrat
Course B: Materials for Devices

 Professor M does Science

 <http://www.tcm.phy.cam.ac.uk/~bm418/>

Course B: Materials for Devices

order

disorder



electric polarisation
in materials

magnetism
in materials

ionic conductors

liquid crystals

Metals vs insulators

metals

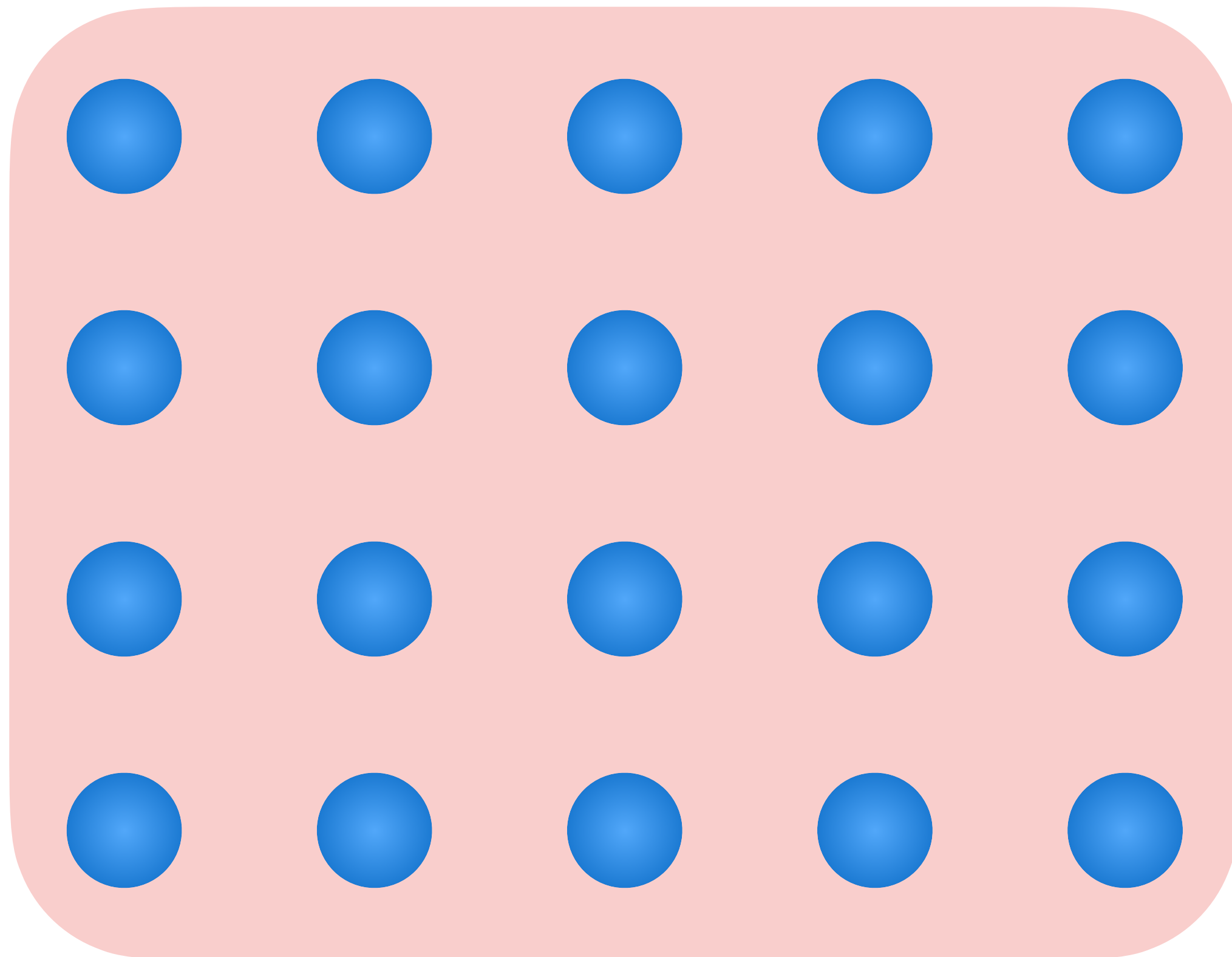

high electronic conductivity

insulators

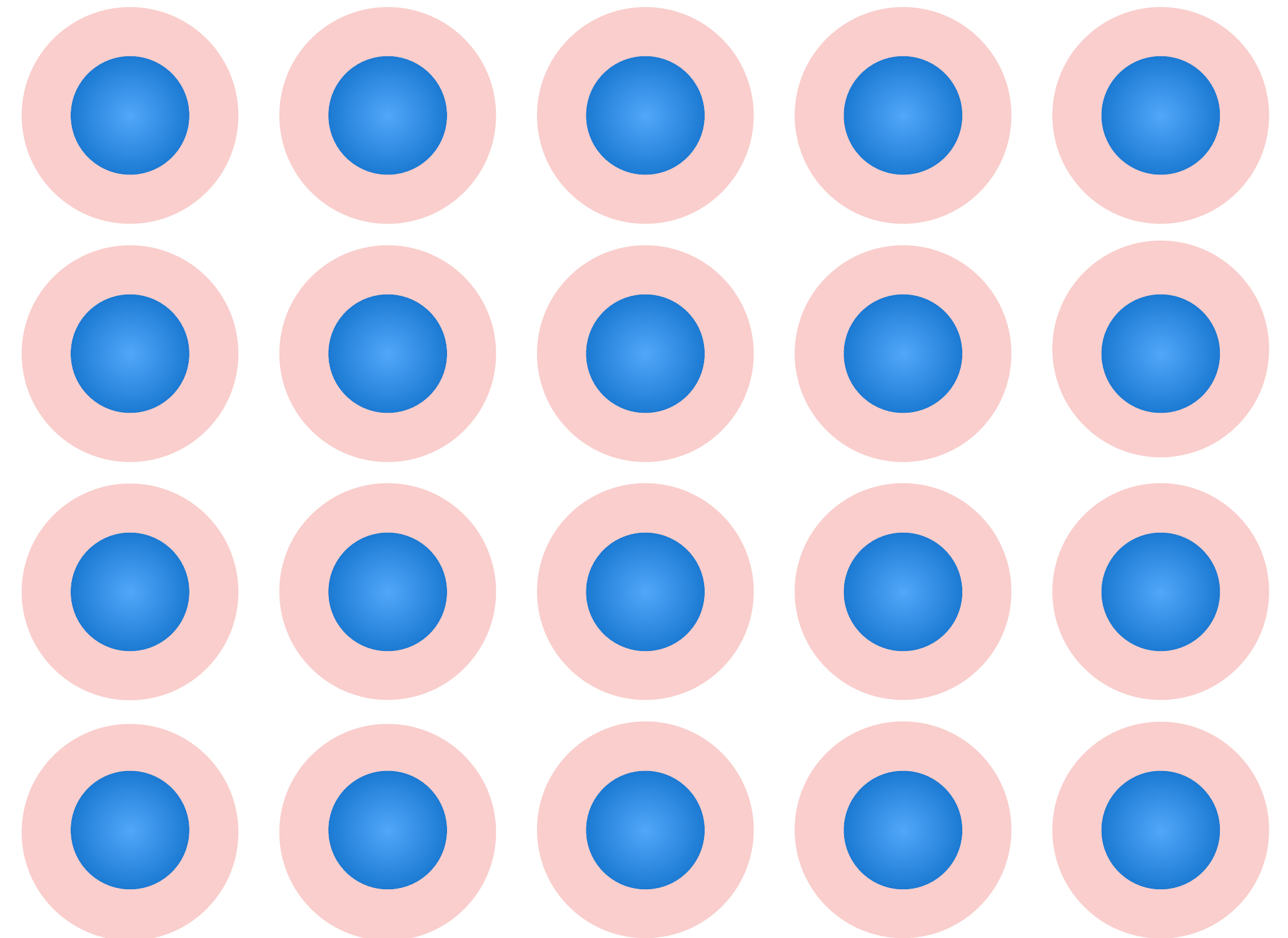

low electronic conductivity

Metals vs insulators

metals

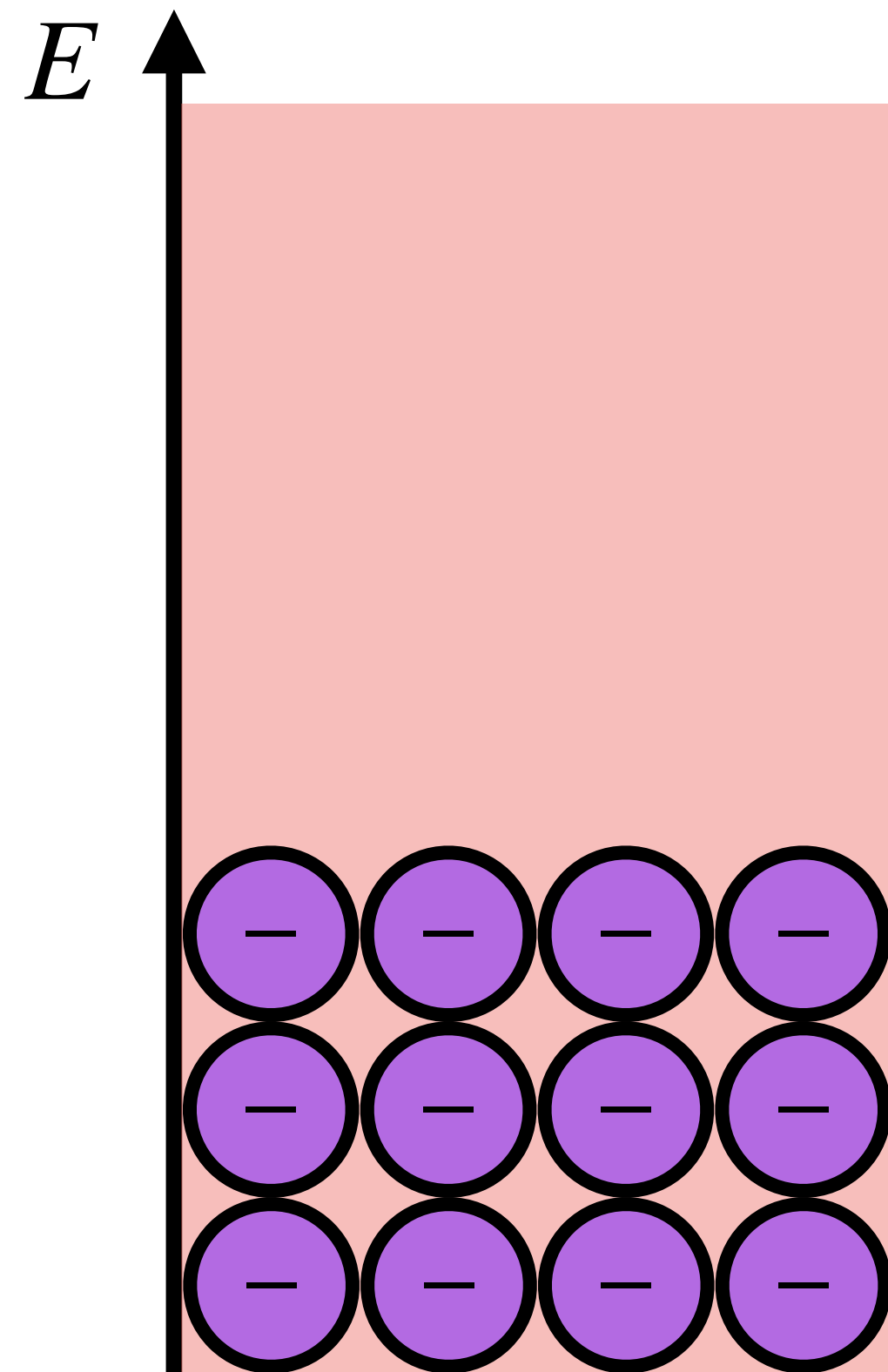

high electronic conductivity

insulators

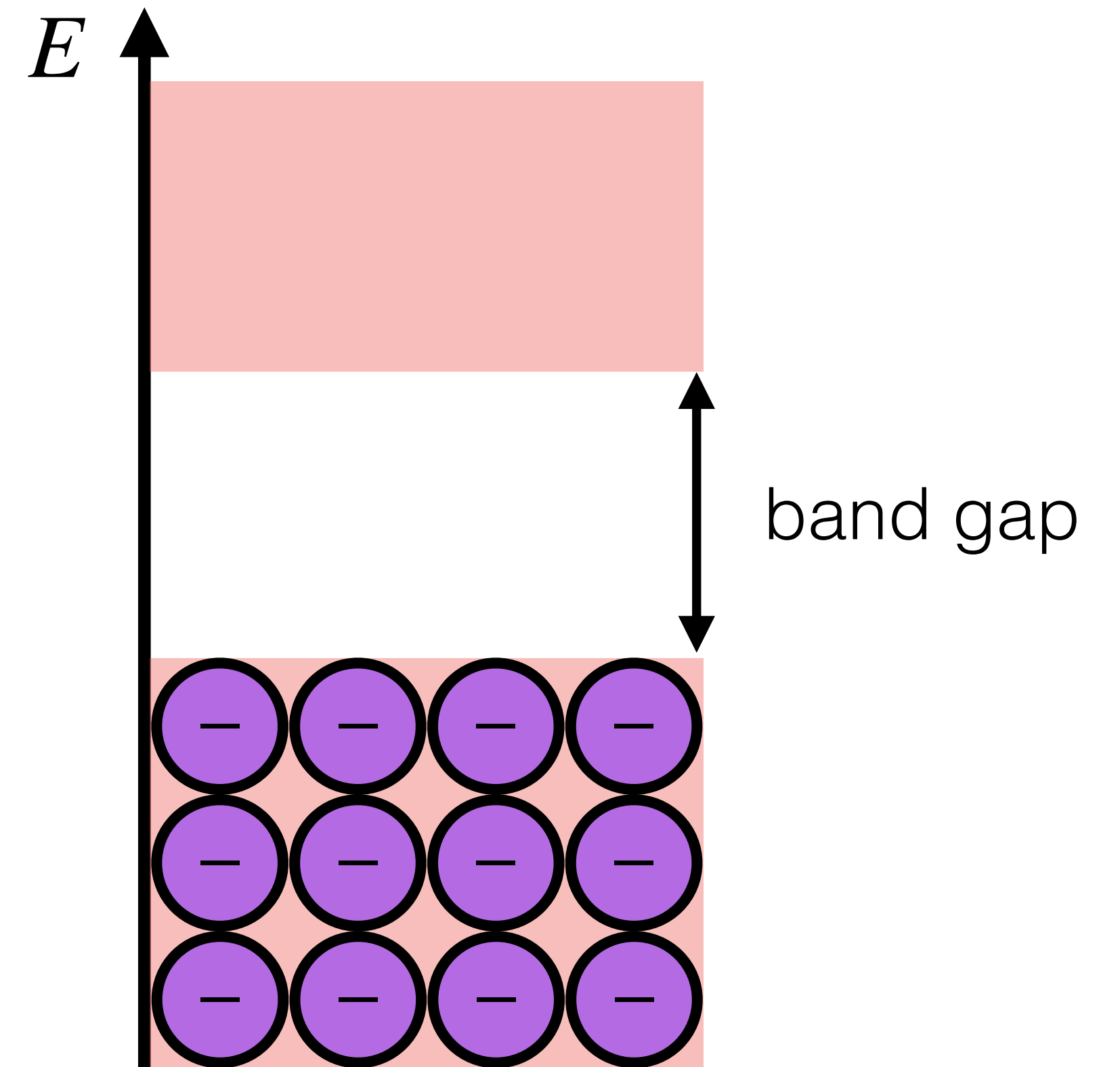

low electronic conductivity

Metals vs insulators

metals

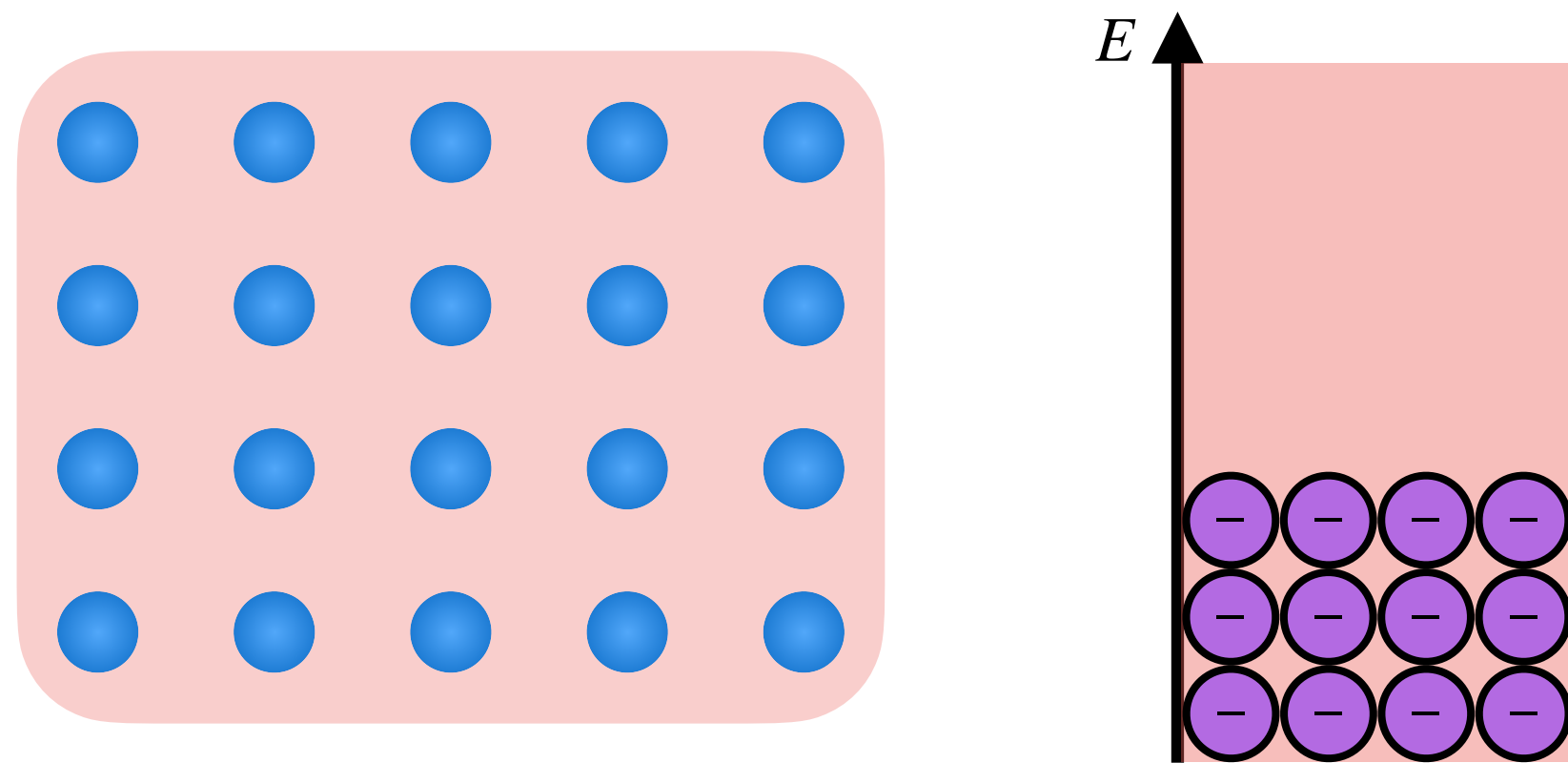

- ▶ Silver (Ag): $\sigma = 6.3 \times 10^7 \text{ Sm}^{-1}$
- ▶ Copper (Cu): $\sigma = 6.0 \times 10^7 \text{ Sm}^{-1}$
- ▶ Gold (Au): $\sigma = 4.1 \times 10^7 \text{ Sm}^{-1}$

high electronic conductivity

insulators

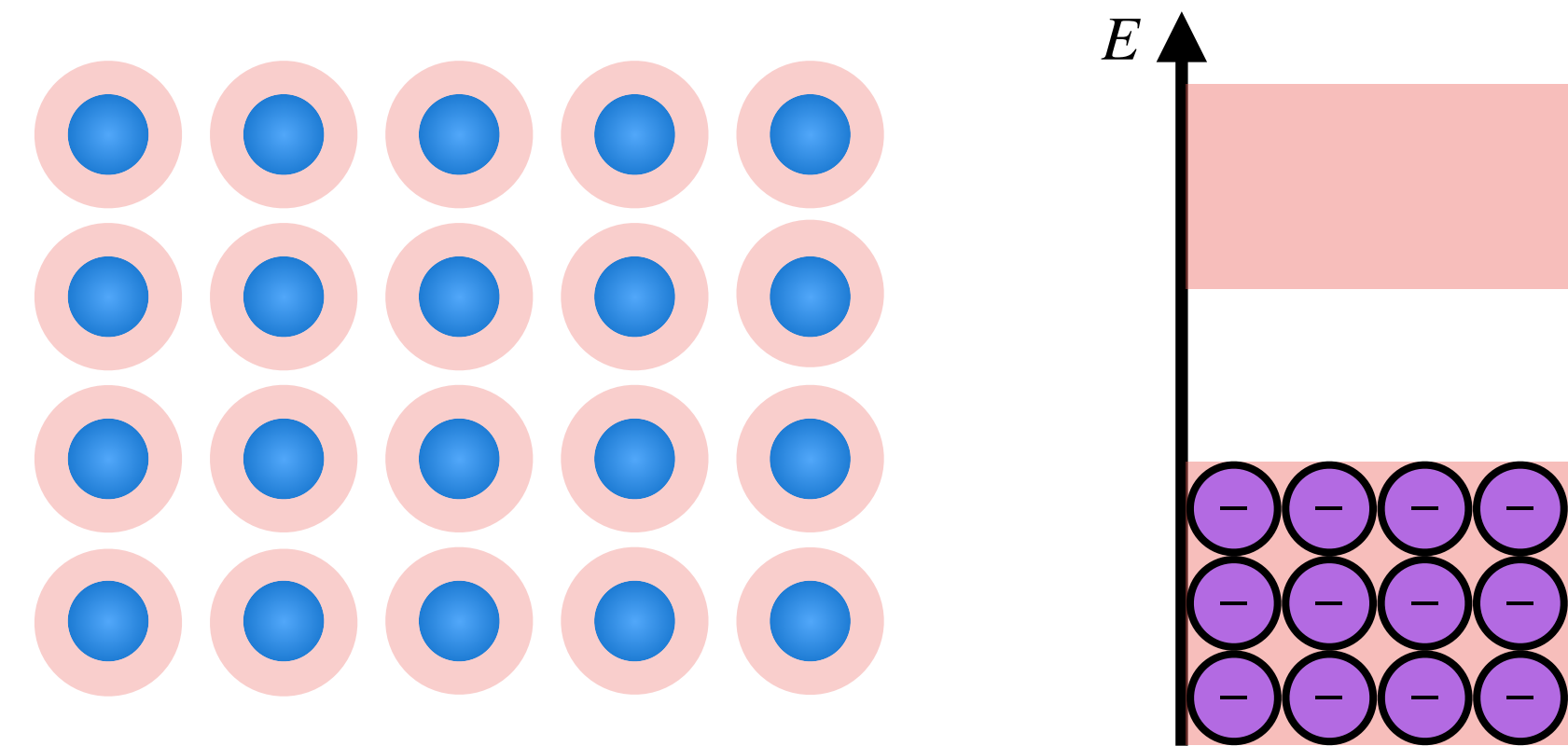

- ▶ Air: $\sigma \simeq 5 \times 10^{-15} \text{ Sm}^{-1}$
- ▶ Glass: $\sigma \simeq 10^{-13} \text{ Sm}^{-1}$
- ▶ Al_2O_3 : $\sigma = 10^{-10} \text{ Sm}^{-1}$

low electronic conductivity

Ionic conduction

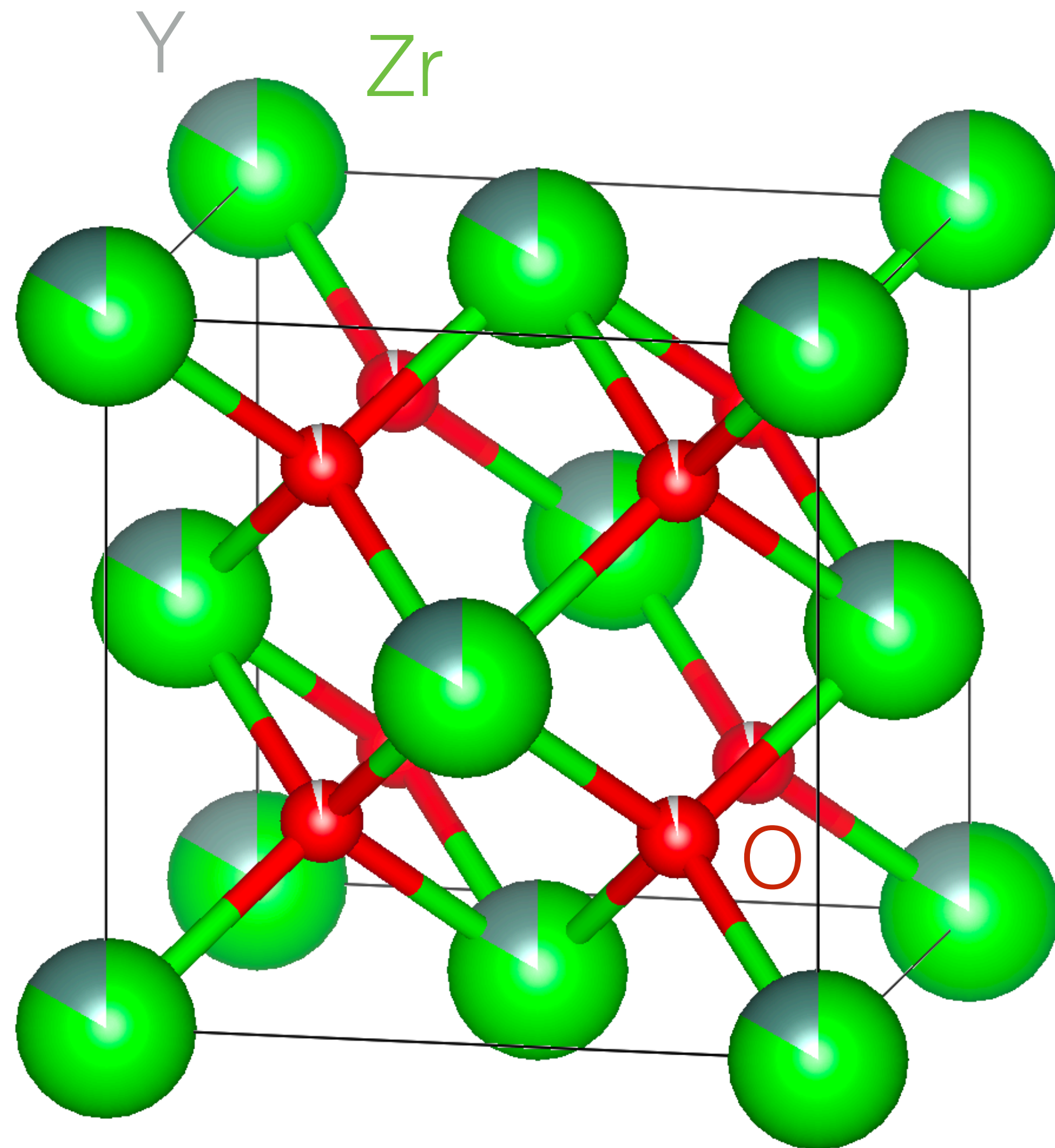

- ▶ Yttrium stabilised zirconia
- ▶ Complex structure (see Lecture 8)
- ▶ No conduction electrons (band gap)

$$\sigma \sim 0.1 \text{ Sm}^{-1}$$

- ▶ Copper (Cu): $\sigma = 6.0 \times 10^7 \text{ Sm}^{-1}$
- ▶ Al_2O_3 : $\sigma = 10^{-10} \text{ Sm}^{-1}$

Random walk and diffusion

- At every time step:

$$P(x_1 \rightarrow x_2) = P(x_2 \rightarrow x_1) \equiv P$$

$$N(x_1) = 10$$

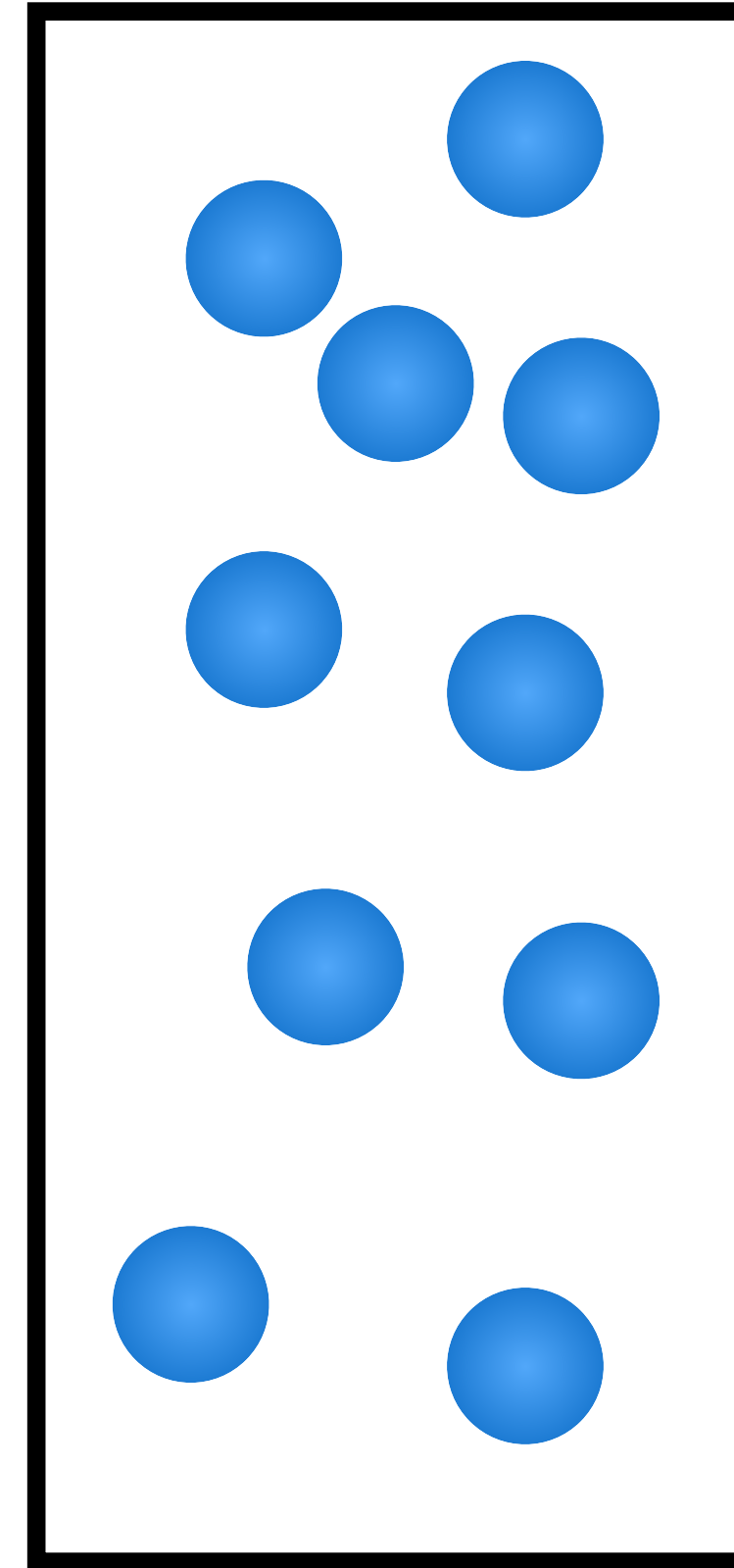

x_1

$$N(x_2) = 4$$

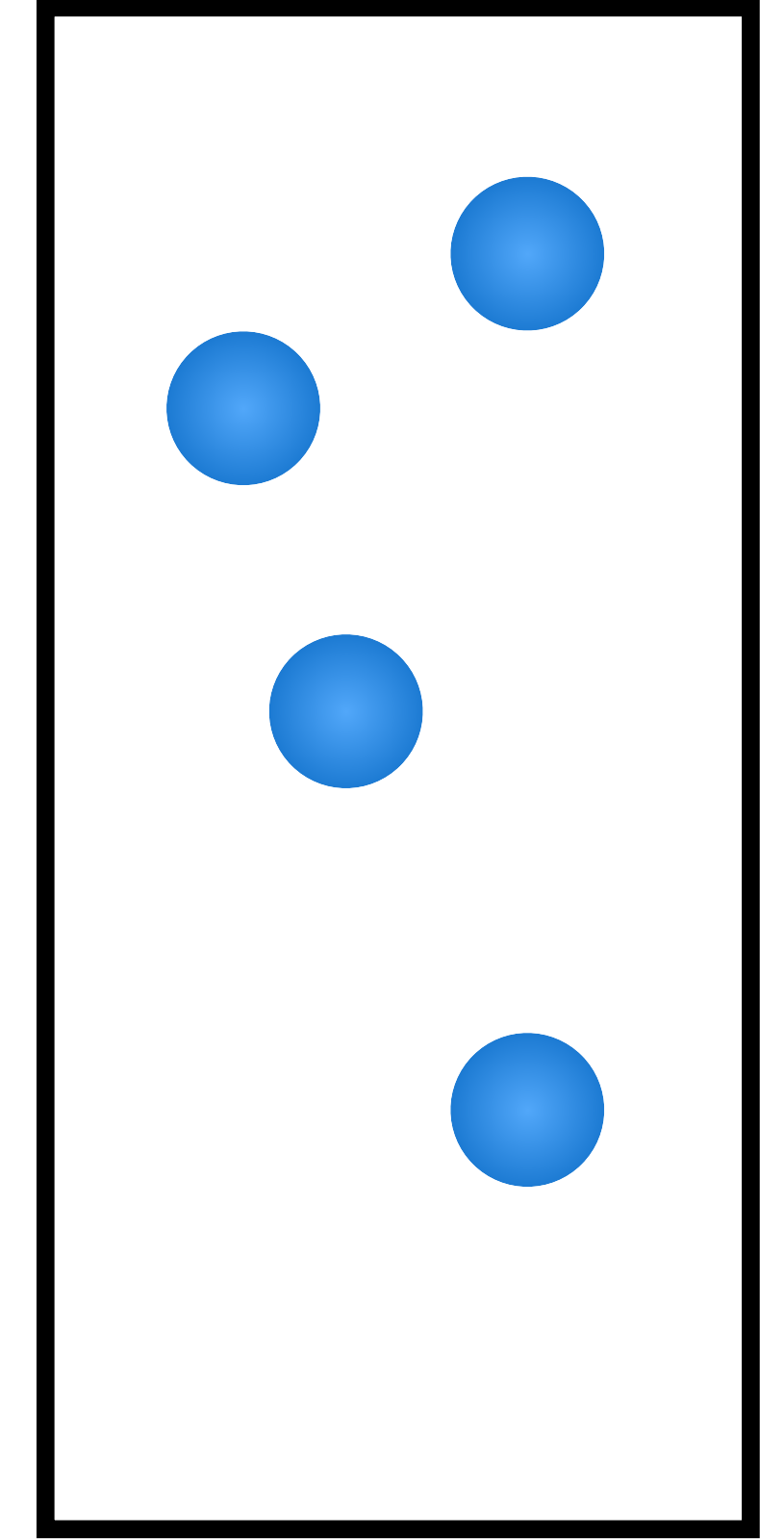

x_2

Random walk and diffusion

- At every time step:

$$P(x_1 \rightarrow x_2) = P(x_2 \rightarrow x_1) \equiv P$$

- Example: $P = 0.5$

$$N(x_1) = 10$$

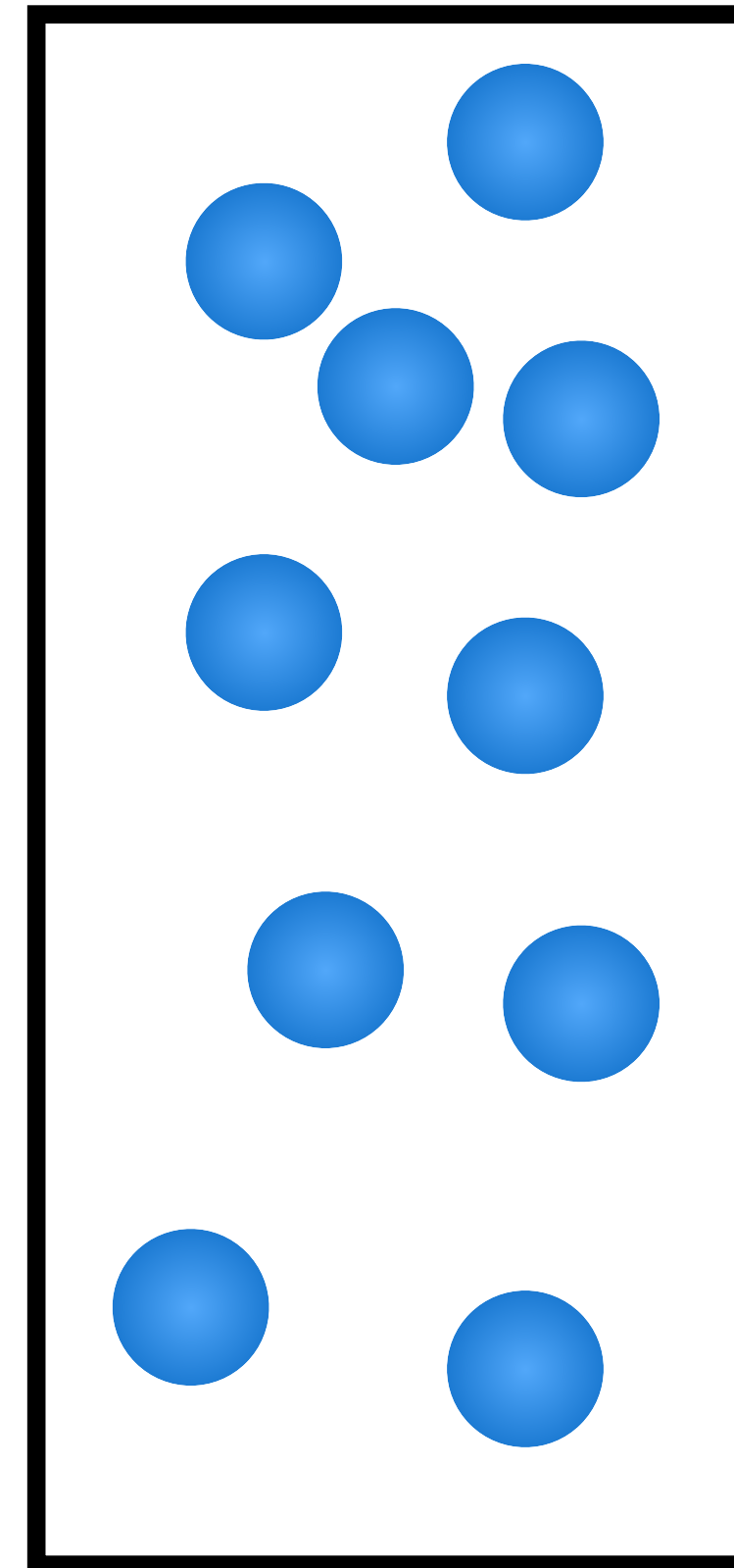

x_1

$$N(x_2) = 4$$

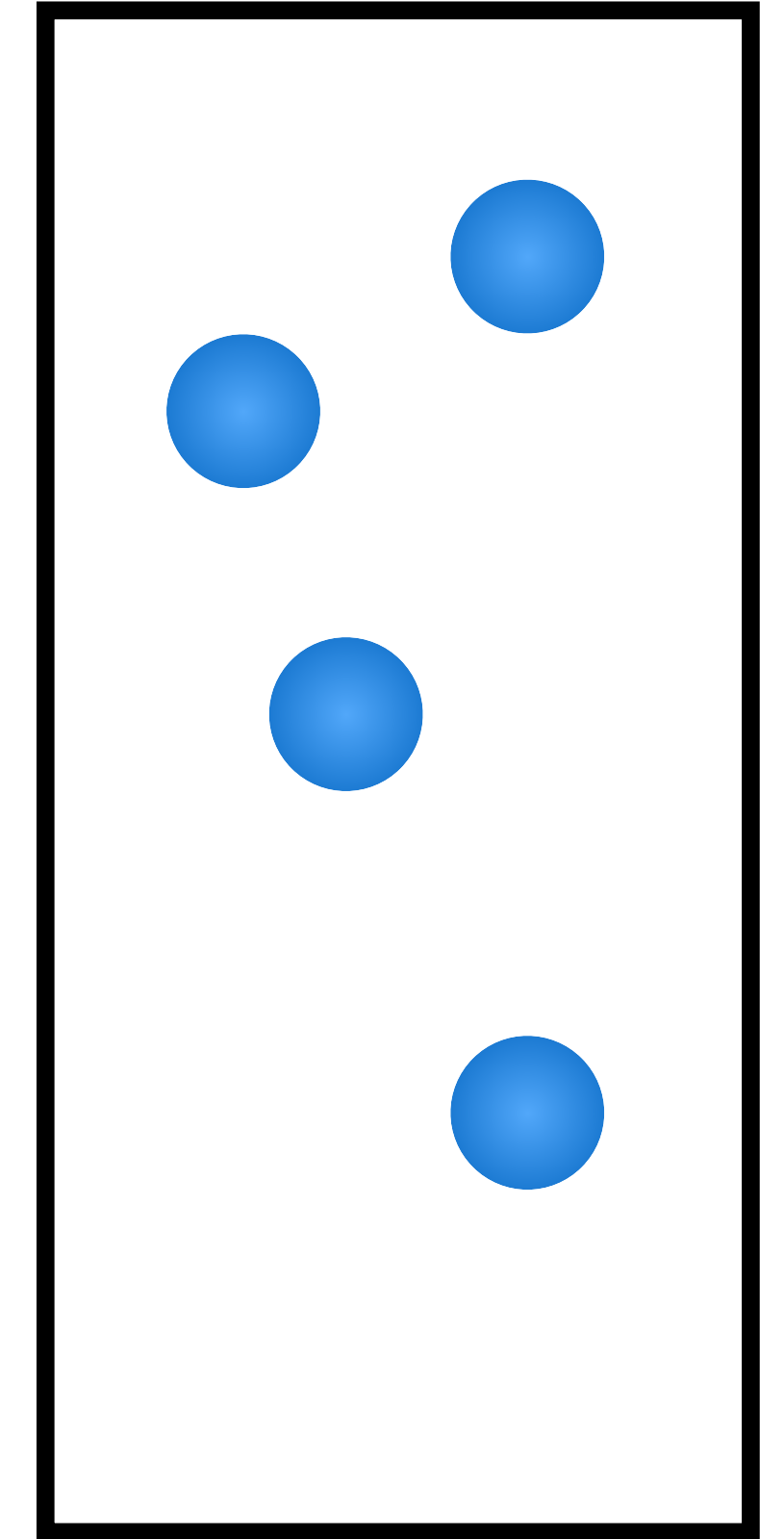

x_2

Random walk and diffusion

- At every time step:

$$P(x_1 \rightarrow x_2) = P(x_2 \rightarrow x_1) \equiv P$$

- Example: $P = 0.5$

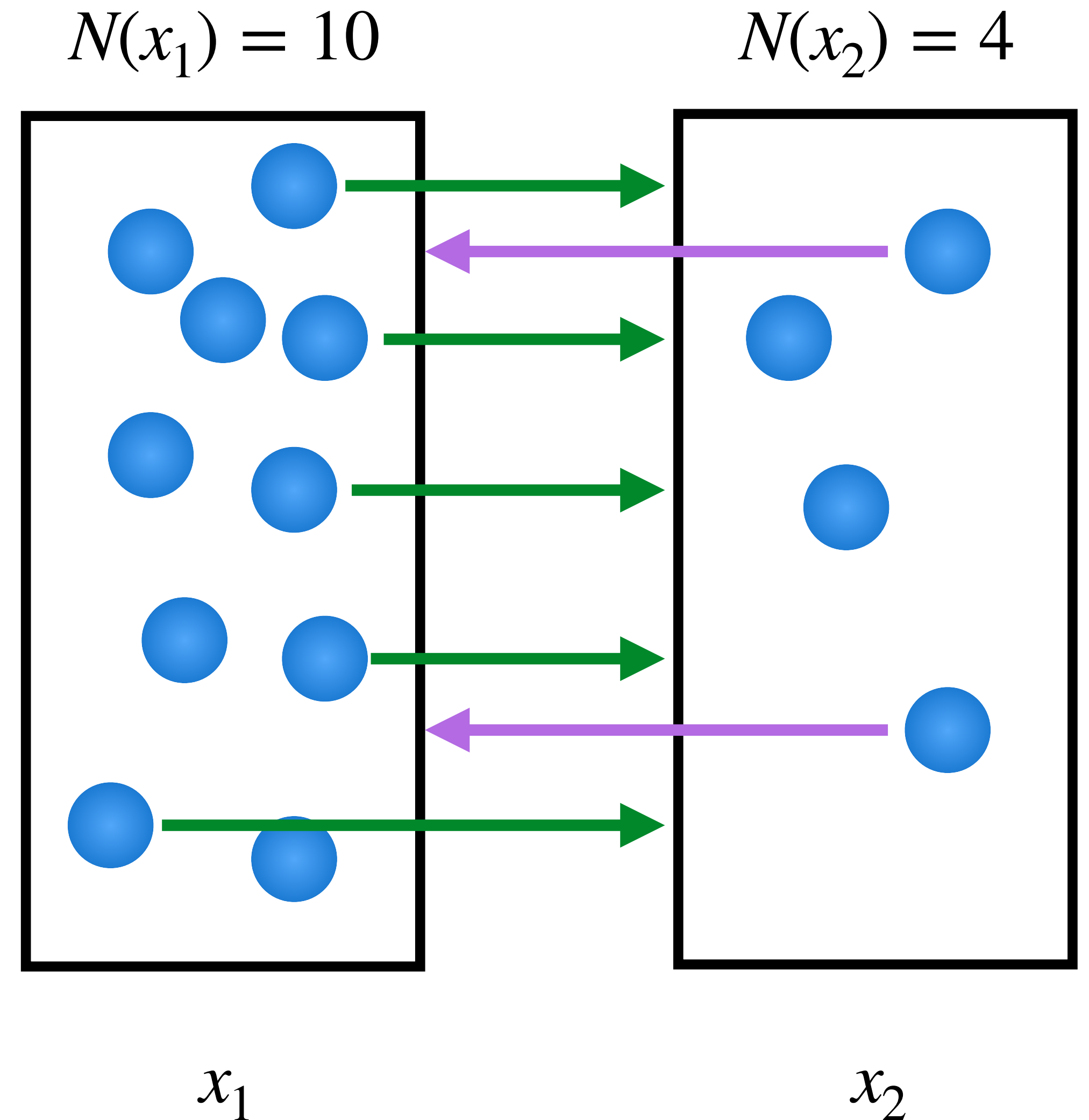

Random walk and diffusion

- At every time step:

$$P(x_1 \rightarrow x_2) = P(x_2 \rightarrow x_1) \equiv P$$

- Example: $P = 0.5$

$$N(x_1) = 7$$

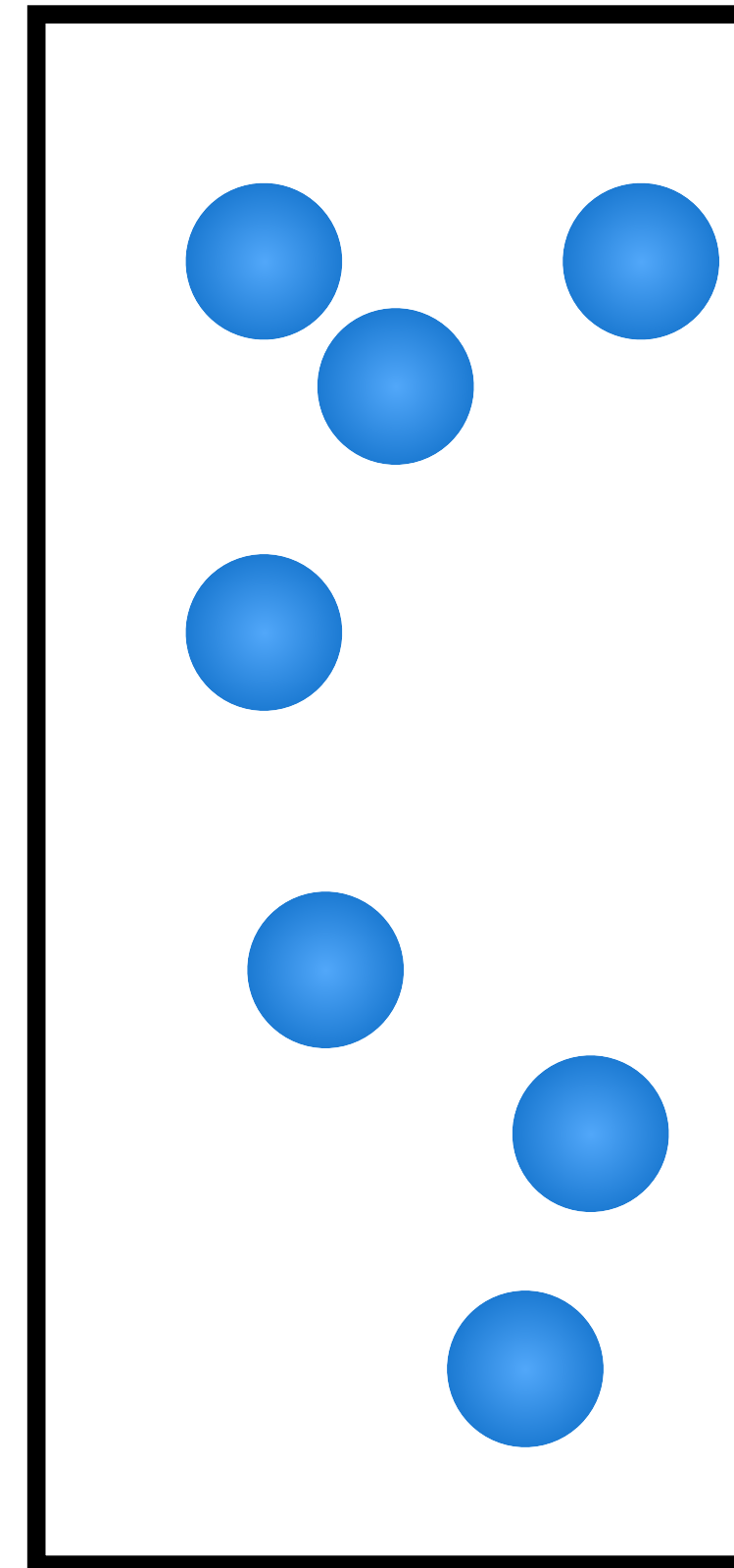

x_1

$$N(x_2) = 7$$

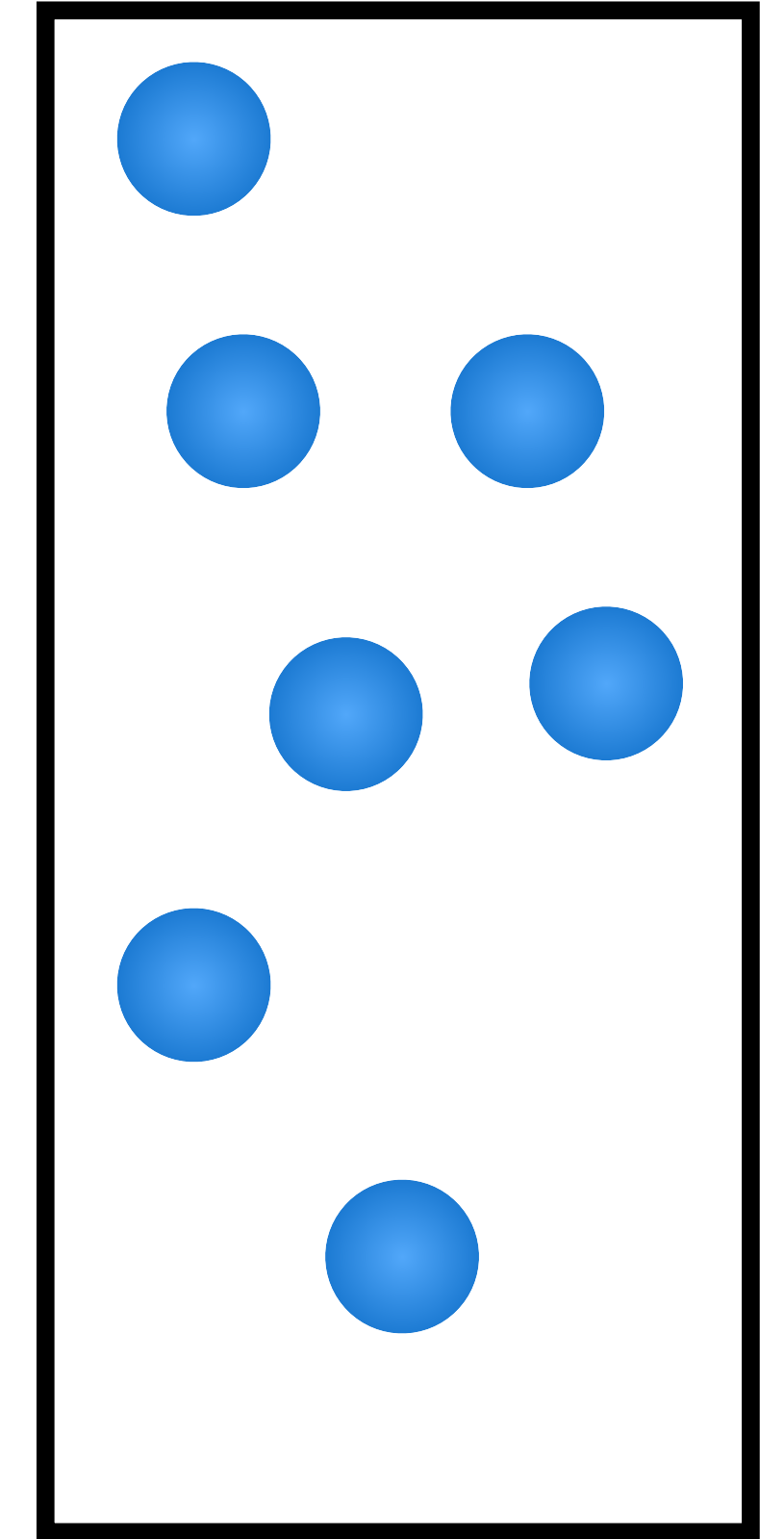

x_2

Random walk and diffusion

- At every time step:

$$P(x_1 \rightarrow x_2) = P(x_2 \rightarrow x_1) \equiv P$$

- Example: $P = 0.5$

concentration gradients
lead to diffusion

$$N(x_1) = 7$$

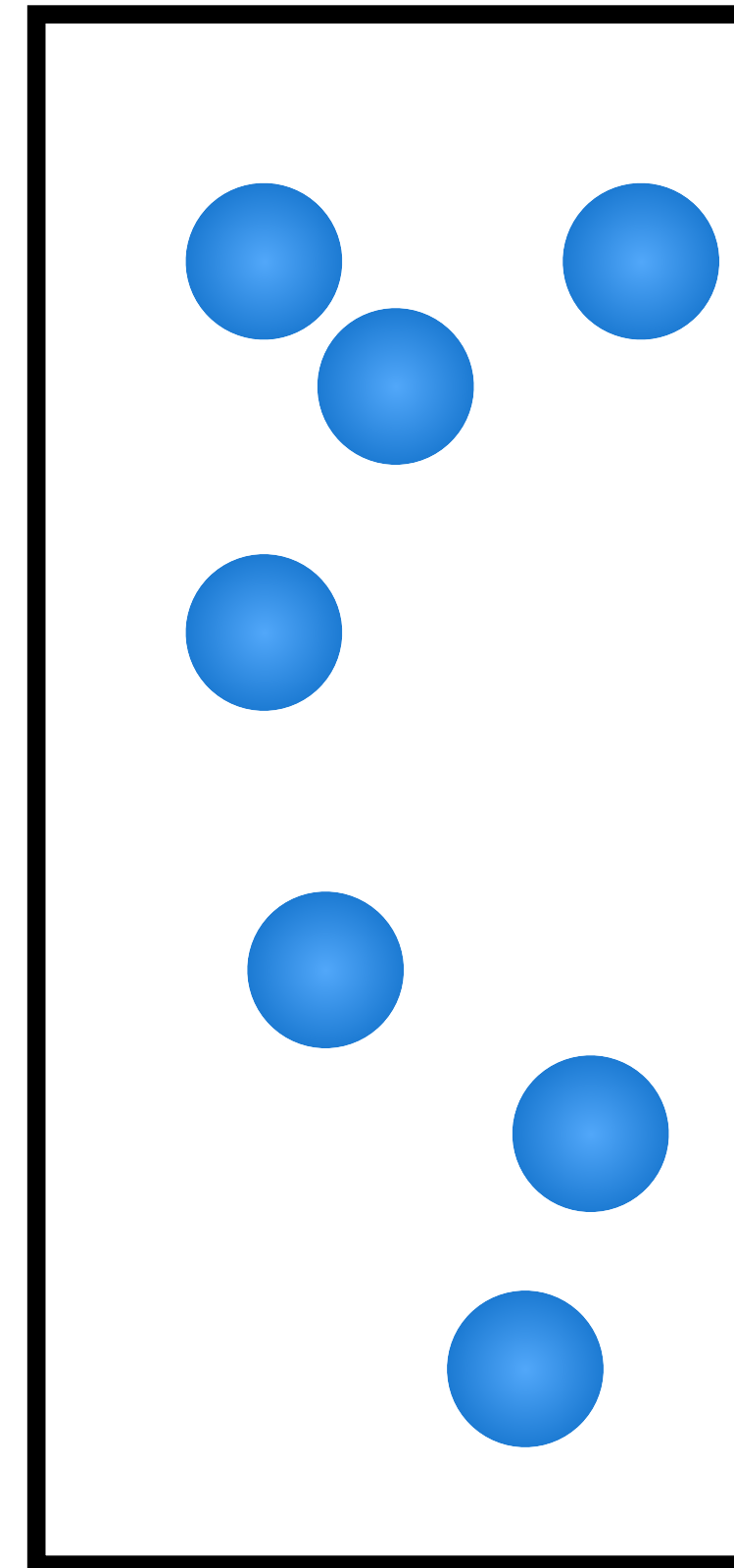

x_1

$$N(x_2) = 7$$

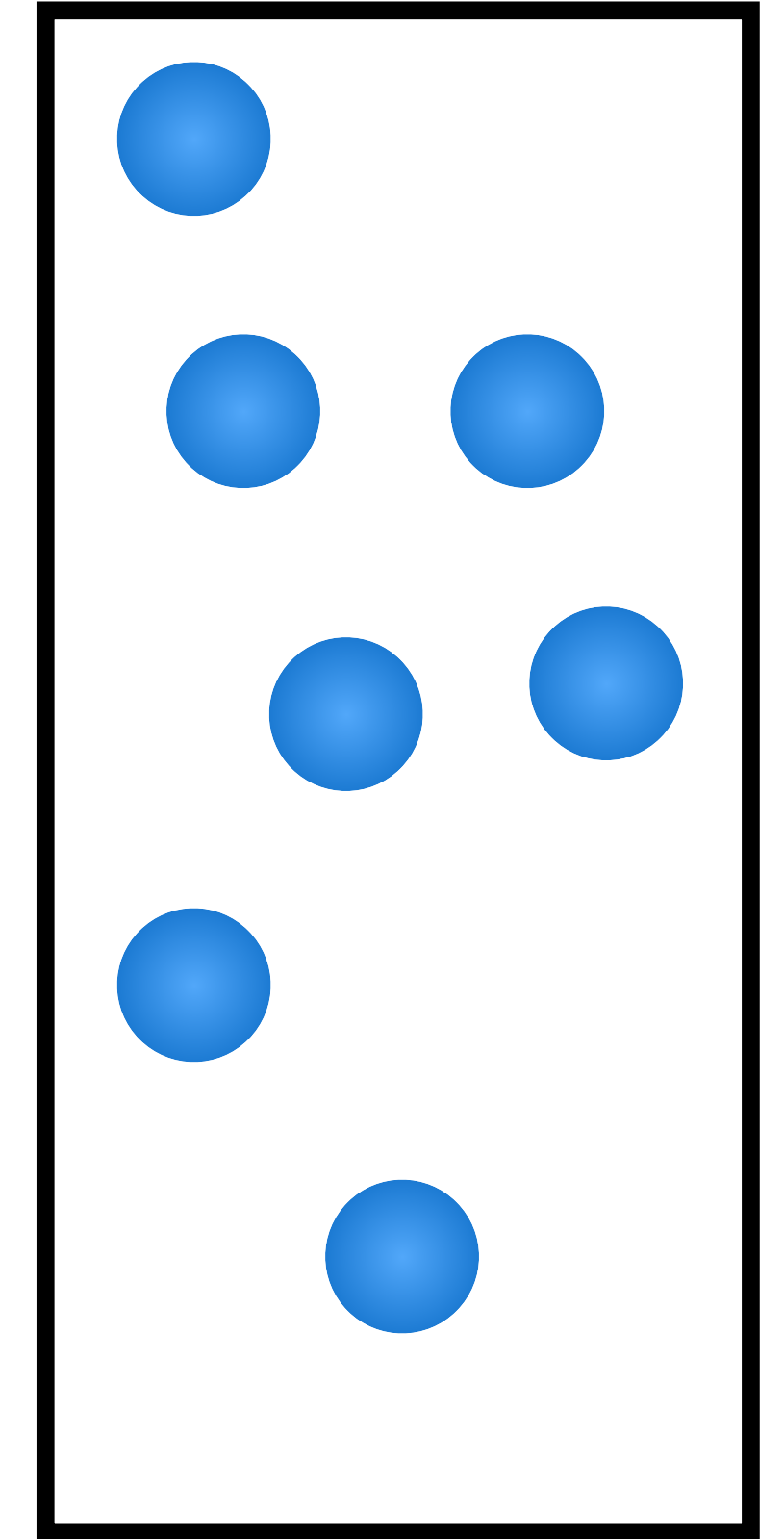

x_2

Random walk and diffusion

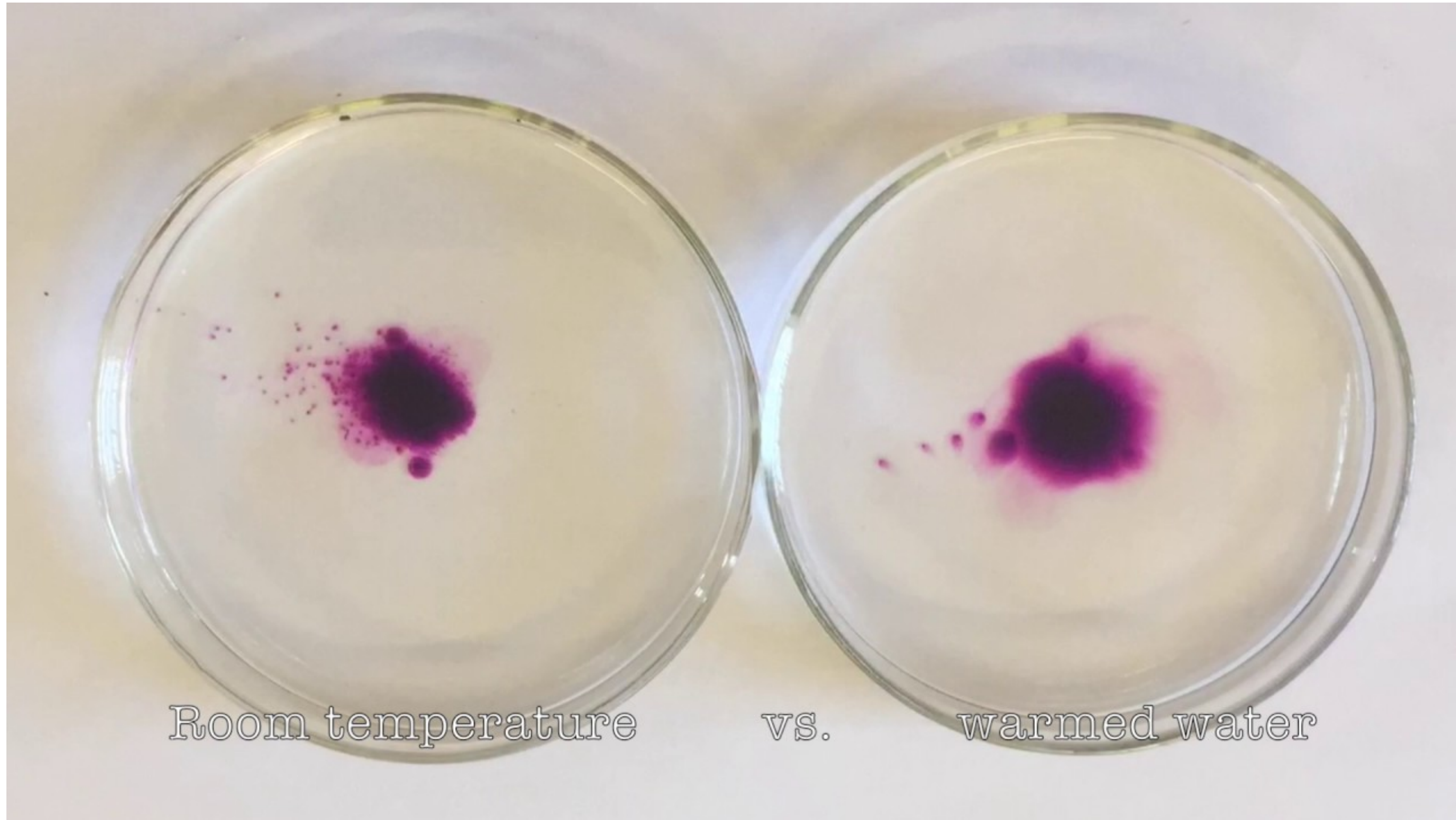

Diffusion flux

- Diffusion flux: number of ions crossing unit area in unit time

$$J = \frac{I}{A}$$

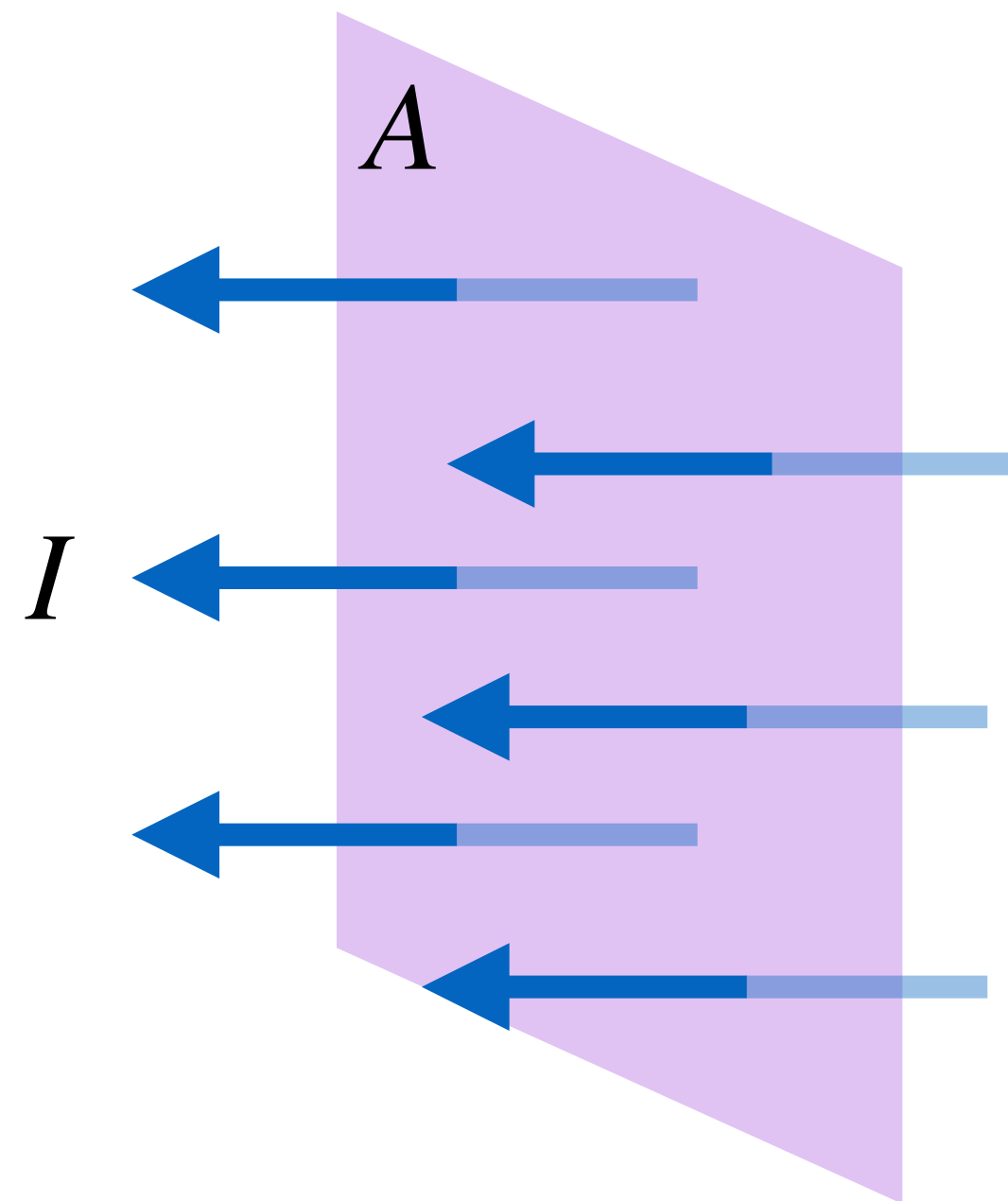

J : diffusion flux $[\text{m}^{-2}\text{s}^{-1}]$

I : current of ions $[\text{s}^{-1}]$

A : area $[\text{m}^2]$

Fick's first law of diffusion

$$J_x = -D \frac{\partial n}{\partial x}$$

J_x : diffusion flux $[\text{m}^{-2}\text{s}^{-1}]$

D : diffusion coefficient or diffusivity $[\text{m}^2\text{s}^{-1}]$

n : number density of diffusing particles (concentration) $[\text{m}^{-3}]$

x : position $[\text{m}]$

Fick's first law of diffusion

$$J_x = -D \frac{\partial n}{\partial x}$$

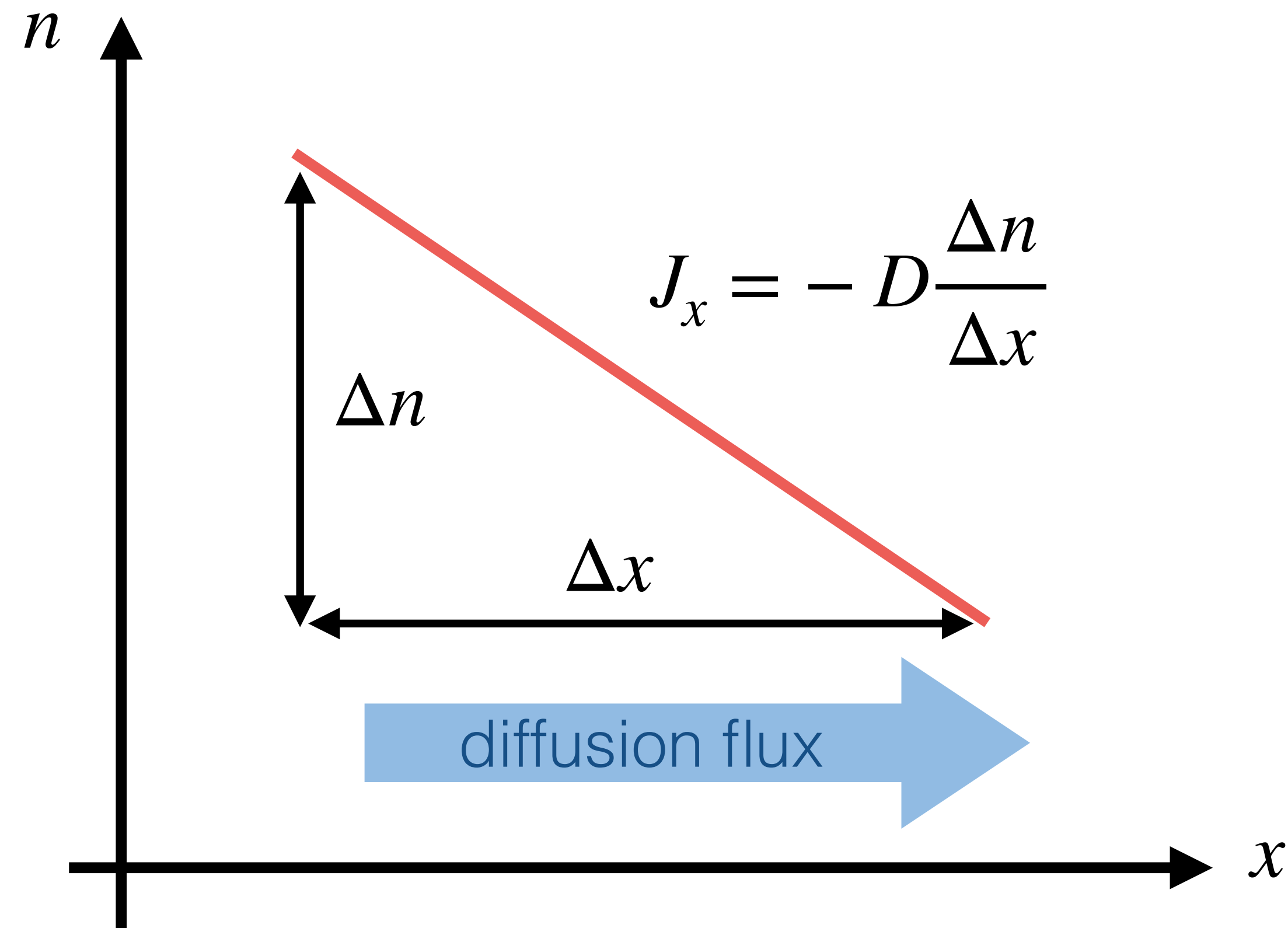

Current density

$$J_x = -D \frac{\partial n}{\partial x}$$

- ▶ Ion of charge q :

$$j_x = -qD \frac{\partial n}{\partial x}$$

j_x : current density [A m⁻²]

q : ionic charge [C]

D : diffusion coefficient or diffusivity [m²s⁻¹]

n : number density of diffusing particles (concentration) [m⁻³]

x : position [m]

Aside: Fick's second law of diffusion

$$\frac{\partial n}{\partial t} = D \frac{\partial^2 n}{\partial x^2}$$

n : number density of diffusing particles (concentration) $[\text{m}^{-3}]$

D : diffusion coefficient or diffusivity $[\text{m}^2\text{s}^{-1}]$

t : time $[\text{s}]$

x : position $[\text{m}]$

Ohm's law

$$I = \frac{V}{R}$$

I : current [A]

V : voltage [V]

R : resistance [Ω]

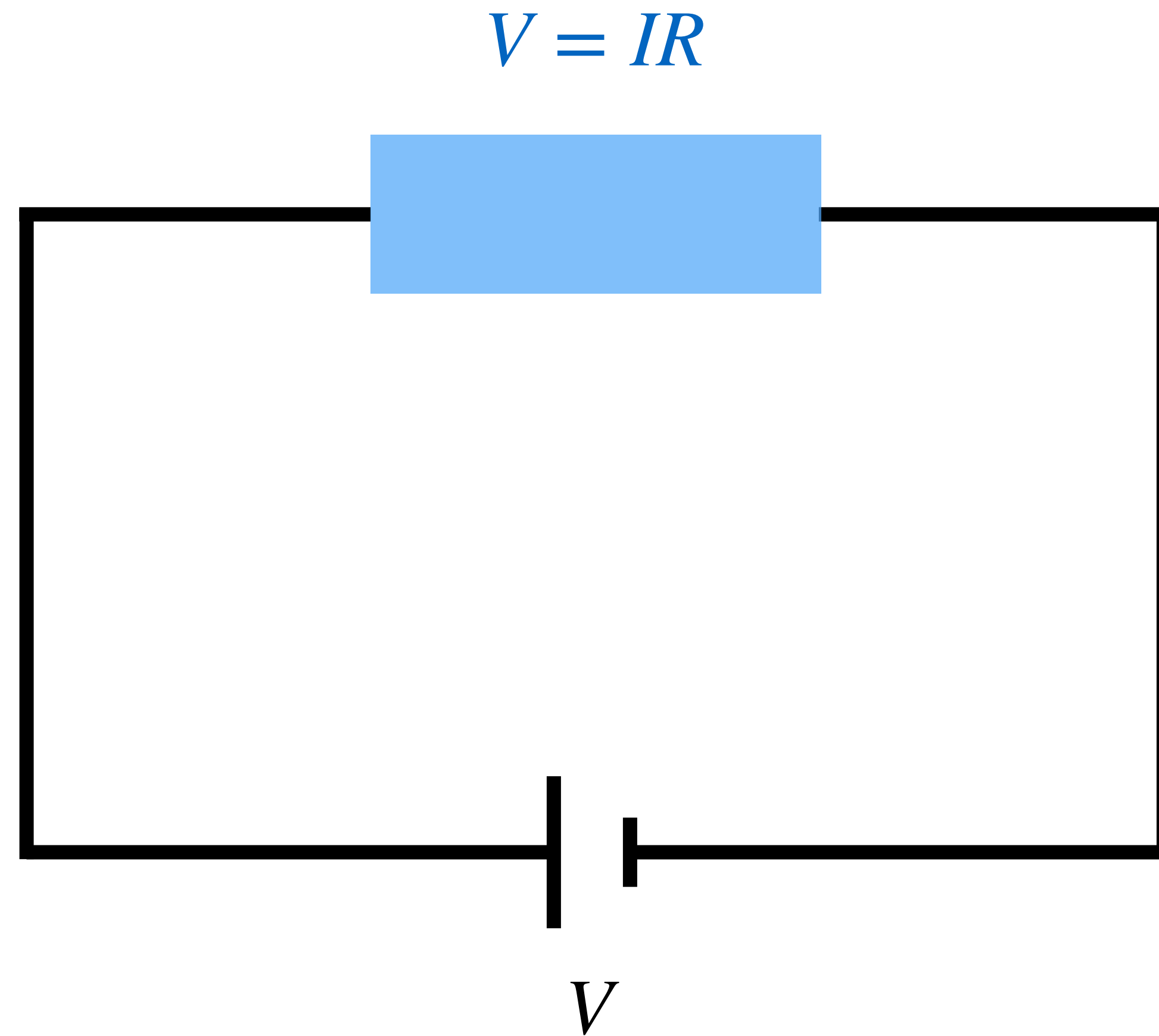

Ohm's law

$$I = \frac{V}{R}$$

I : current [A]

V : voltage [V]

R : resistance [Ω]

$$\mathbf{j} = \sigma \mathbf{E}$$

\mathbf{j} : current density [Am^{-2}]

\mathbf{E} : electric field [Vm^{-1}]

σ : conductivity [Sm^{-1}]

Ohm's law

$$I = \frac{V}{R}$$

I : current [A]

V : voltage [V]

R : resistance [Ω]

$$j_x = \sigma E_x = -\sigma \frac{\partial V}{\partial x}$$

j_x : current density [Am^{-2}]

E_x : electric field [Vm^{-1}]

σ : conductivity [Sm^{-1}]

V : voltage [V]

x : position [m]

Drift current

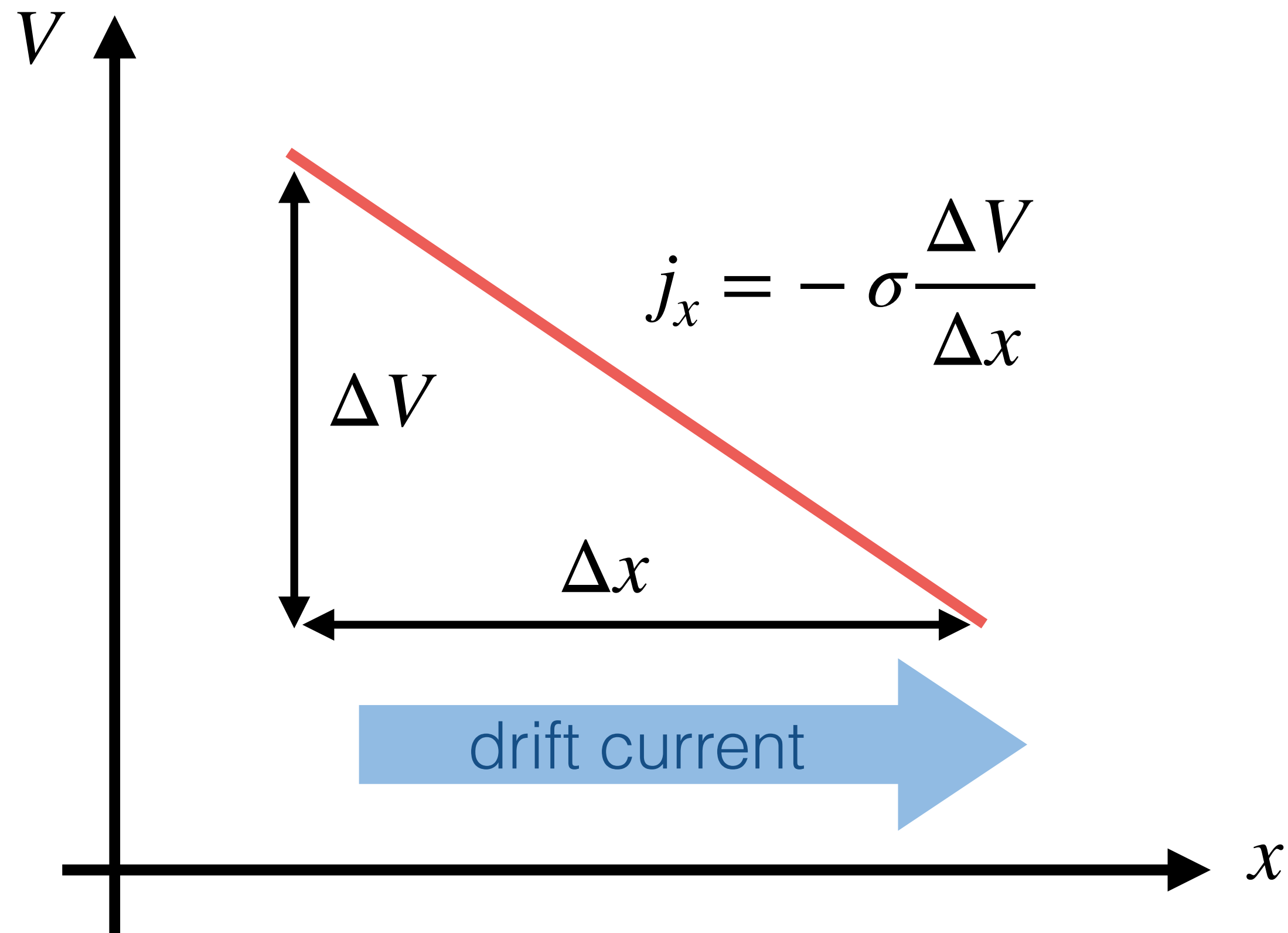

$$j_x = \sigma E_x = -\sigma \frac{\partial V}{\partial x}$$

j_x : current density [Am⁻²]

E_x : electric field [Vm⁻¹]

σ : conductivity [Sm⁻¹]

V : voltage [V]

x : position [m]

Fick's equation with drift current

$$j_x = -qD \frac{\partial n}{\partial x} - \sigma \frac{\partial V}{\partial x}$$

Fick's equation with drift current: steady state

$$j_x = -qD \frac{\partial n}{\partial x} - \sigma \frac{\partial V}{\partial x}$$

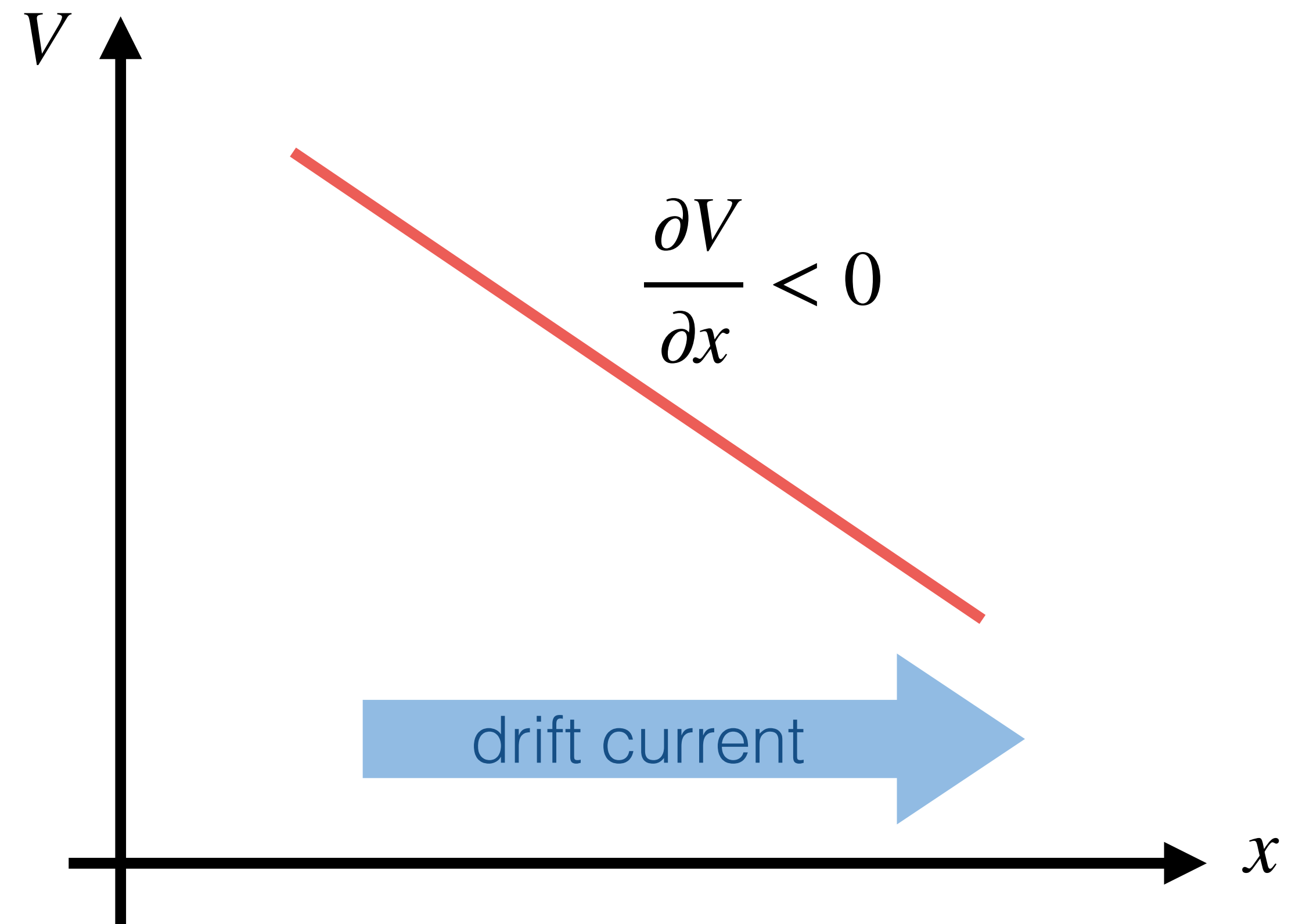
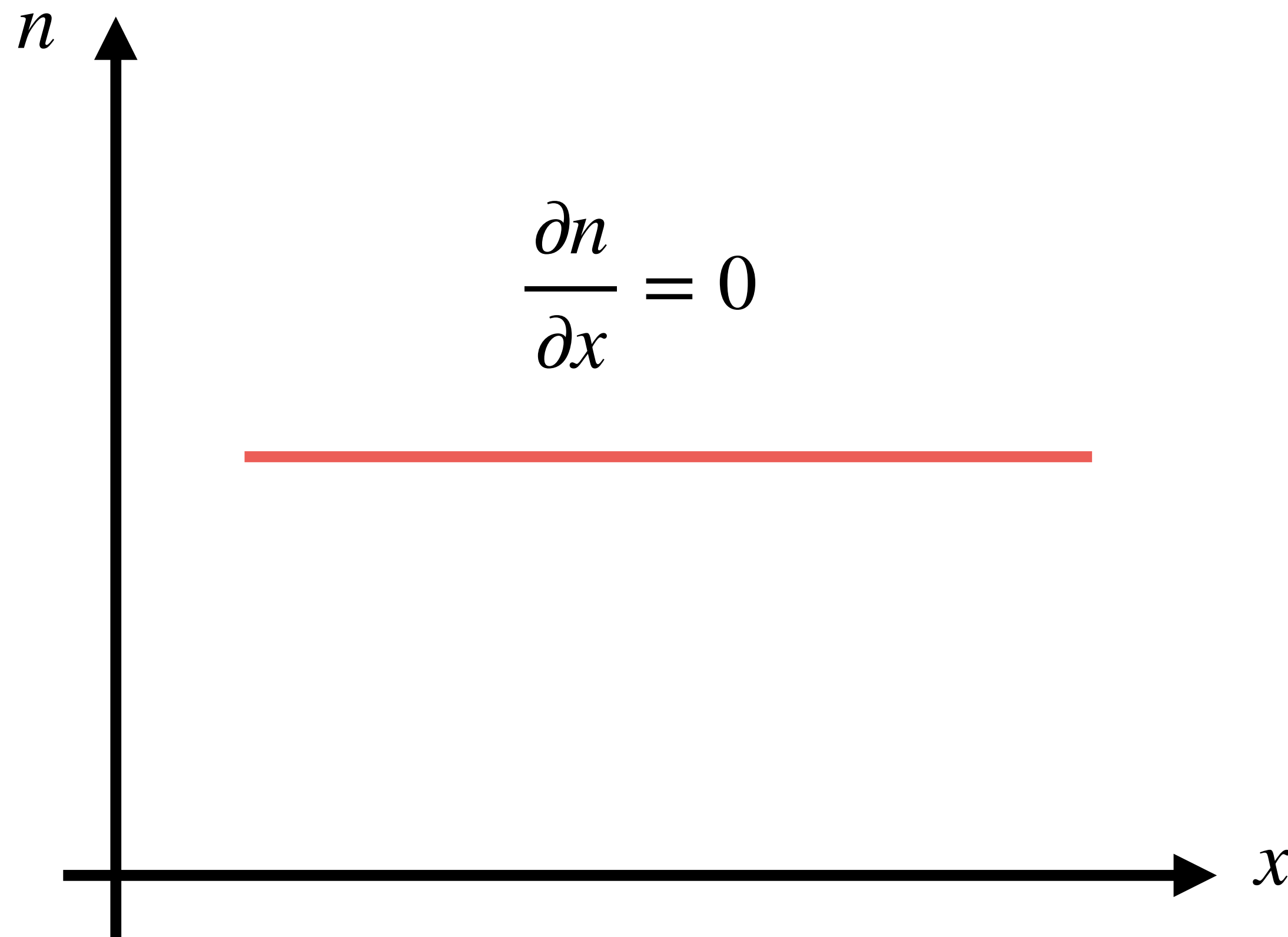

Fick's equation with drift current: steady state

$$j_x = -qD \frac{\partial n}{\partial x} - \sigma \frac{\partial V}{\partial x}$$

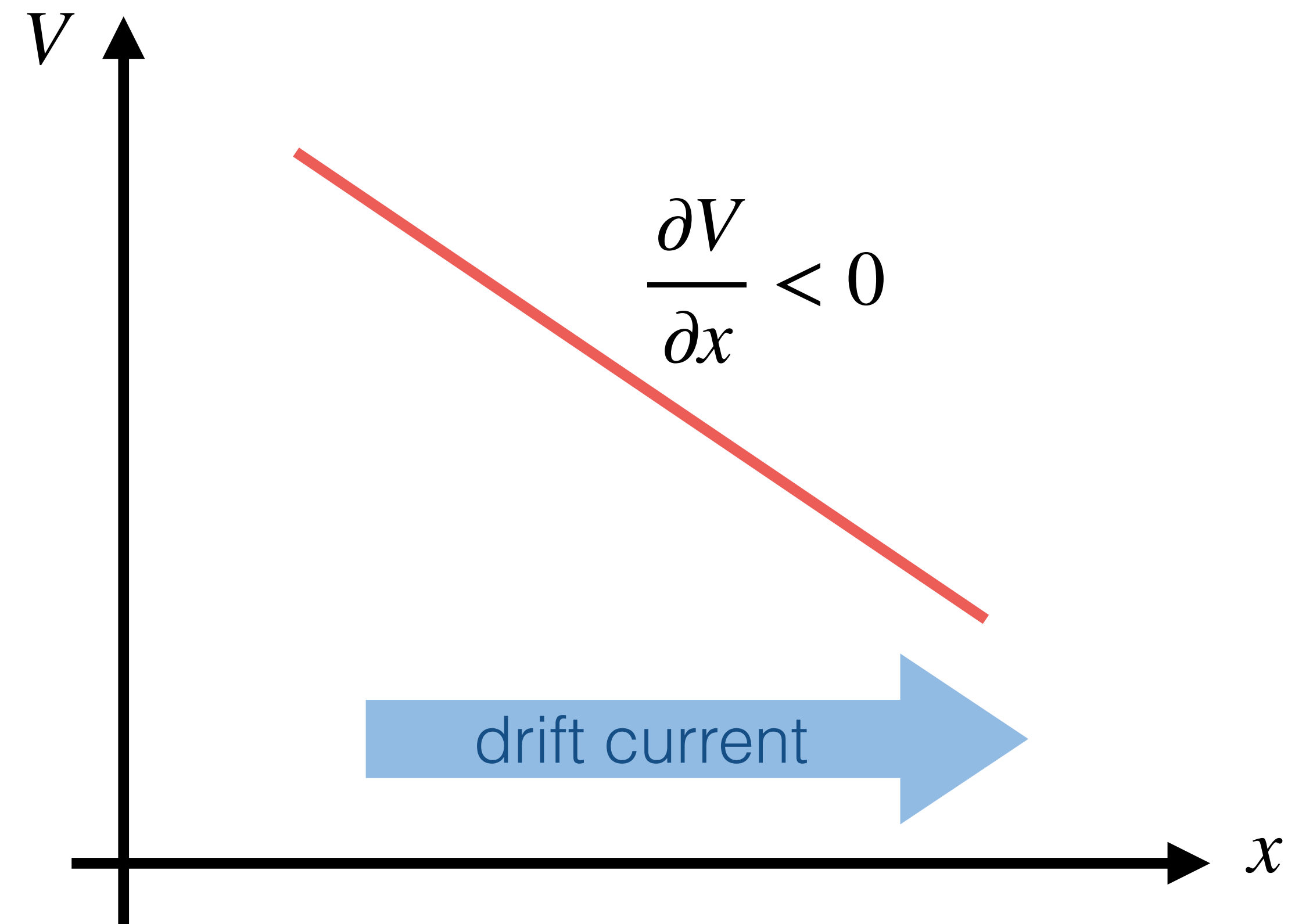
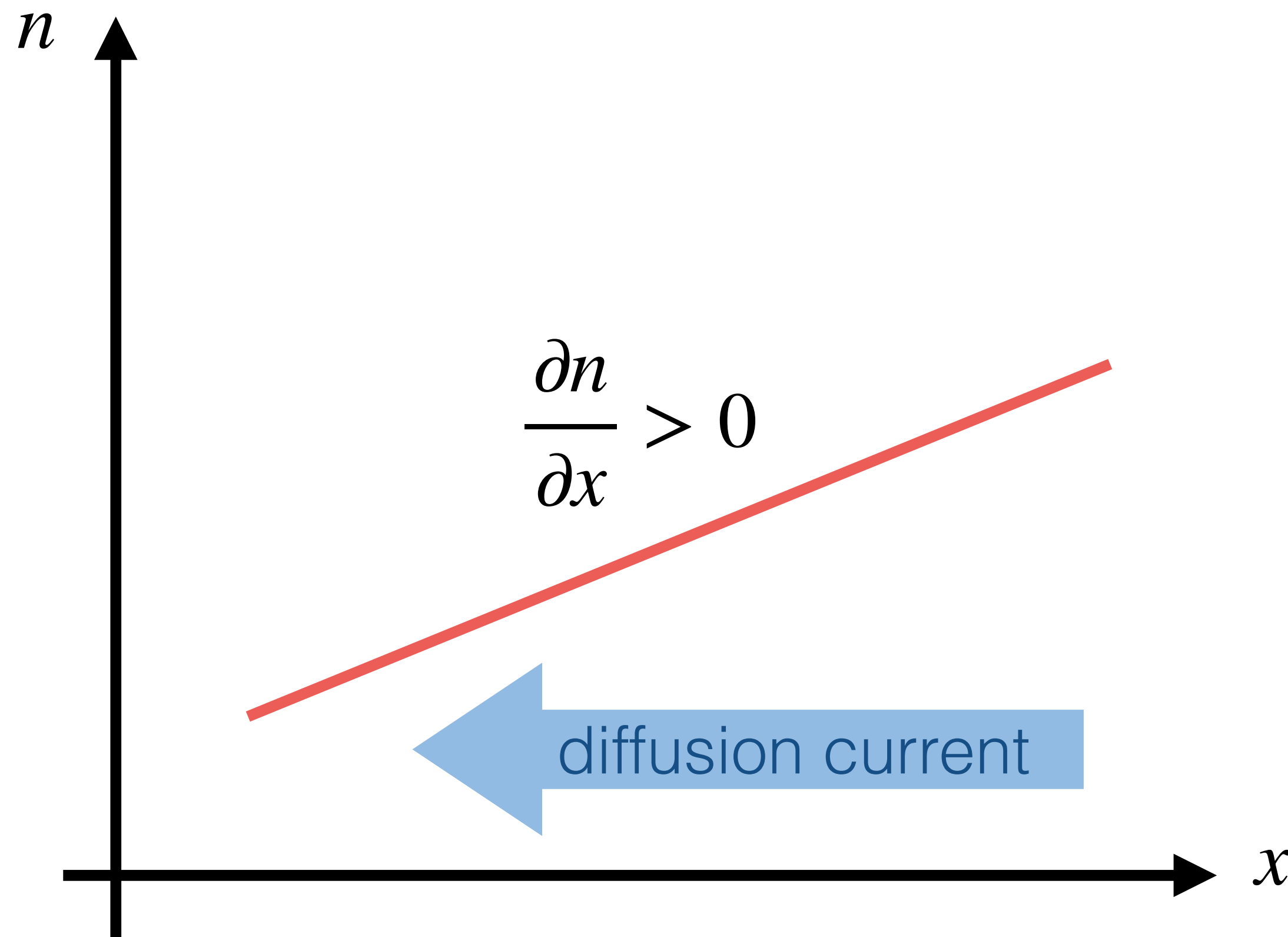

Fick's equation with drift current: steady state

$$j_x = -qD \frac{\partial n}{\partial x} - \sigma \frac{\partial V}{\partial x} = 0$$

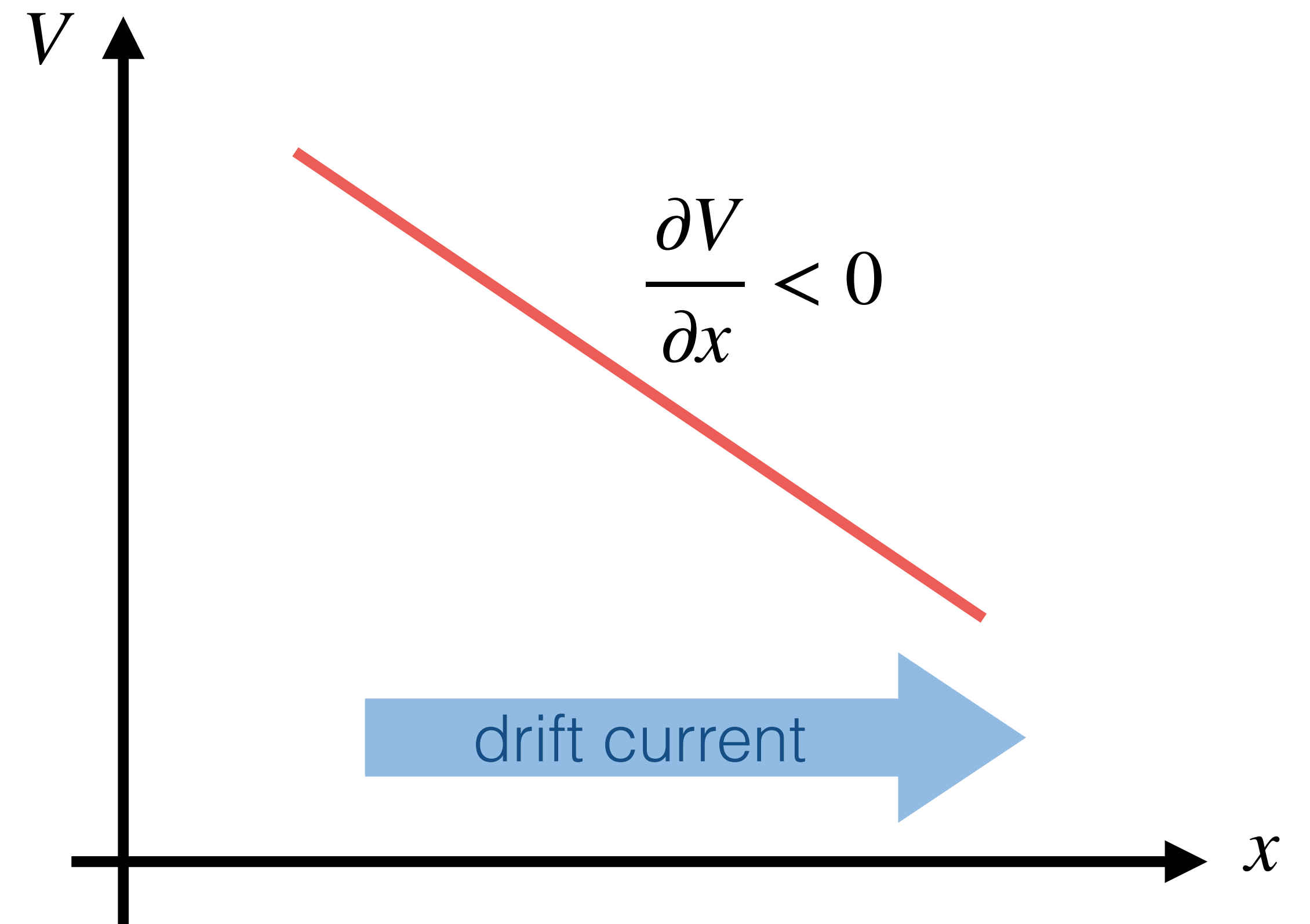
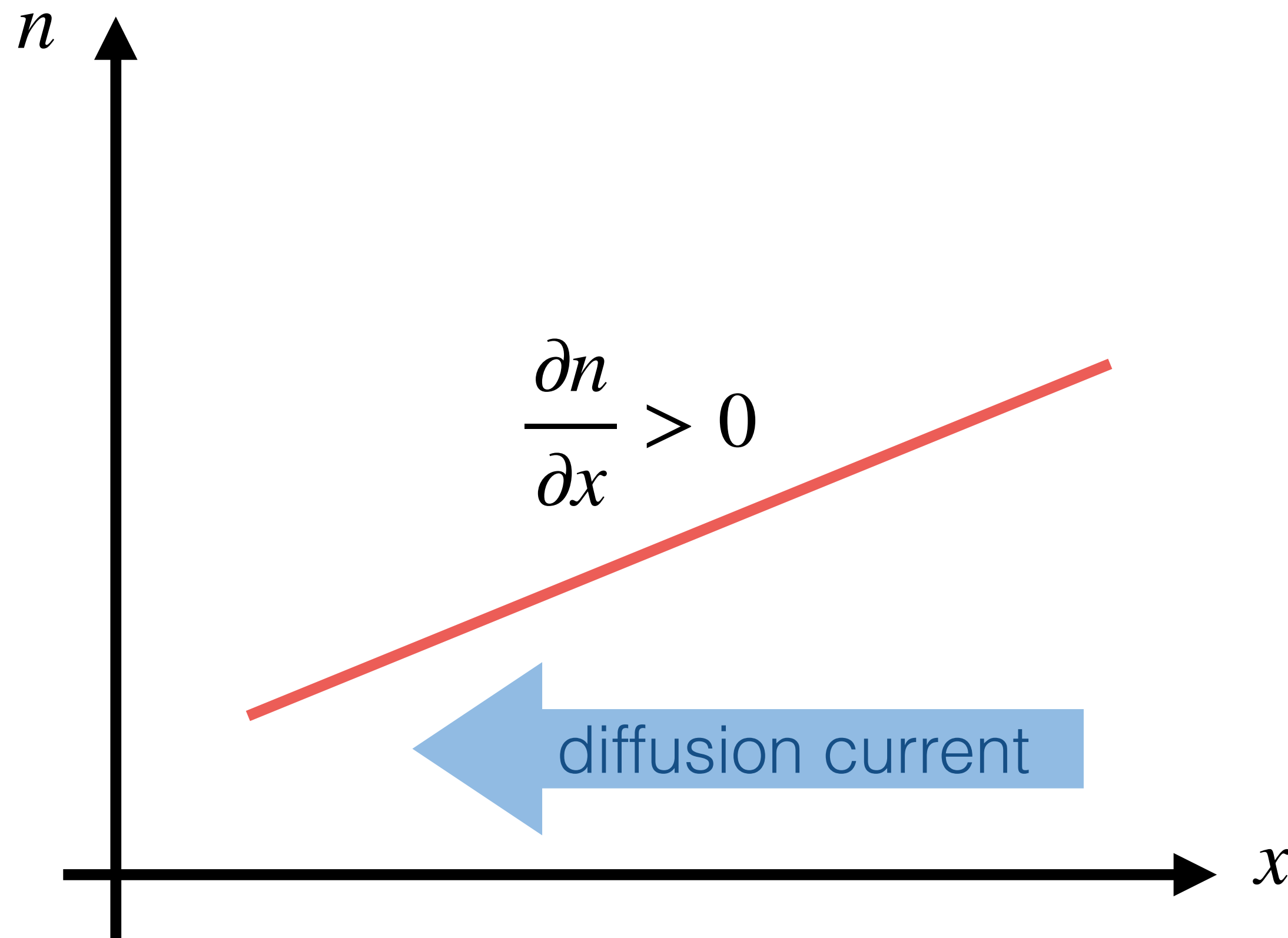

Nernst-Einstein equation

- *Derivation of Nernst-Einstein equation in Problem Set 3*

$$\frac{\sigma}{D} = \frac{nq^2}{k_B T}$$